



SAINT-GAUDENS

SOLID BRONZE HARDWARE

the beauty of fine design, the eternity of solid bronze

McCALL



SOLID BRONZE

Saint-Gaudens Hardware

is designed to provide lasting service. Made of the highest quality materials and engineered to meet strict safety standards, this hardware will provide years of useful service and distinguish your home as extraordinary.

Distinctively styled and crafted, Saint-Gaudens is designed to provide consistency in both style and finish to your décor. McCall's simple, understated elegance is available in two refined finishes – Dark Bronze – Fine (DBF) and Satin Bronze – Fine (SBF).



dark bronze fine



satin bronze fine

How to Order:

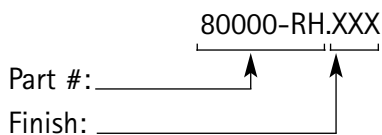

INDEX

Tubular Lock Sets	3-5
Mortise Lock Sets	6-7
Product Listing	8-9

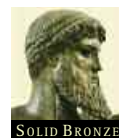

SAINT-GAUDENS

SOLID BRONZE HARDWARE

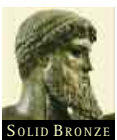

MCCALL

2

McCall Entrance Handle Sets

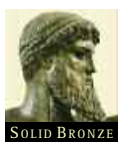

McCall Entrance Handle Sets - Tubular

Applications/Specifications

Applications:

The McCall line of Saint-Gaudens entrance lock has a very simple, elegant design. McCall was designed to emphasize simple understated elegance to highlight the warmth of the bronze finishes. McCall entrance locks are available in tubular or mortise functions. The McCall tubular entrance set is available with a square or a curved grip on the outside and either a round or oval knob or a straight lever inside. The rustic finishes, which are Saint-Gaudens trademark, have been softened to enhance the stepped edges of the McCall, and are designated as Dark Bronze Fine, and Satin Bronze Fine.

Advantages:

- ▶ Tubular sets offer ease of installation using standard 2-1/8" door prep (ANSI 161 for 2-3/8" backset)
- ▶ Solid Bronze Knobs/Levers/Escutcheon
- ▶ Solid brass 5-pin 'C' keyway cylinder standard

Specifications:

Handing

Non-handed for Knobs. Handed for Levers.

Door Thickness

1-3/4" (44mm) to 2-1/8" (54mm) standard.

Backset

2-3/8" (66mm) latch standard.
2-3/4" (70mm) optional.

Faceplate

2-1/4" (57mm) x 1-1/8" (29mm) square corner latch faceplate standard

Bolt

Deadbolt constructed of solid brass. Deadbolt has 1" (25mm) throw when extended with a hardened steel insert for maximum protection and security. Latchbolt constructed of stainless steel. Latchbolt has a 1/2" (13mm) throw when extended to fully engage the door jamb.

Strike

Latch is furnished with a 'T' strike. Latch and deadbolt furnished with a dust box.

Center to Center(CTC) (lock to deadbolt)

Tubular - 5-1/2" (CTC) standard template.

Door Preparation

2-1/8" dia. (54mm) face bore with no additional hardware. 1" (25mm) latch bore.

Cylinder

Solid brass, 5-pin, 'C' keyway standard. Cylinder is protected with a free-turning cylinder guard to resist gripping or twisting by vandals.

Keying

Cylinders easily re-keyed for individual job requirements.

Keys

Two polished brass Saint-Gaudens large bow keys standard. Designed with 1-1/4" (32mm) wide bow surface to facilitate use by physically challenged individuals.

Finishes

Dark Bronze -Fine, Satin Bronze - Fine.

Dimensions

Plate: 3" x 19"



McCall Entrance Handle Sets - Tubular

Functions

Functions:

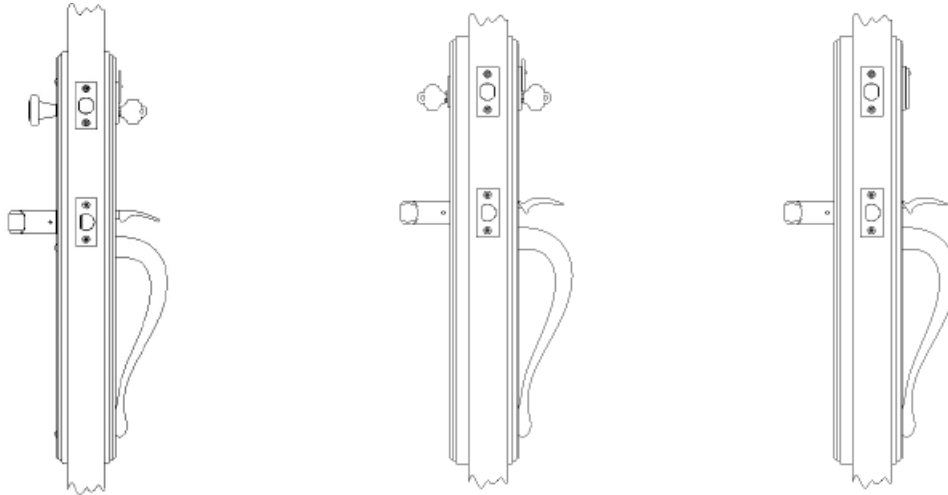

Model

81153-CENTR (RdKnob/Curve Grip)	81153-CDBL (RdKnob/Curve Grip)	81153-CFD (RdKnob/Curve Grip)
81153-SENTR (RdKnob/Str Grip)	81153-SDBL (RdKnob/Str Grip)	81153-SFD (RdKnob/Str Grip)
81053-CENTR (Egg Knob/Curve Grip)	81053-CDBL (Egg Knob/Curve Grip)	81053-CFD (Egg Knob/Curve Grip)
81053-SENTR (Egg Knob/Str Grip)	81053-SDBL (Egg Knob/Str Grip)	81053-SFD (Egg Knob/Str Grip)
81353-CX*ENT (Lever/Curve Grip)	81353-CX*DBL (Lever/Curve Grip)	81353-CX*FD (Lever/Curve Grip)
81353-SX*ENT (Lever/Str Grip)	81353-SX*DBL (Lever/Str Grip)	81353-SX*FD (Lever/Str Grip)

*X = L for LH, R for RH

Function

Handle Set with Single Cylinder Deadbolt

Handle Set with Double Cylinder Deadbolt

Dummy Handle Set with Dummy Deadbolt

Description

Latchbolt operated by thumbpiece outside and grip inside. Deadbolt operated by key outside and thumbturn inside.

Latchbolt operated by thumbpiece outside and grip inside. Deadbolt operated by key both sides.

Handle and grip act as a pull only. For inactive leaf of double doors. No operation.

*Levers are handed –

Please see chart determine the handing of your door.

Professional Installation Required for Full Warranty.

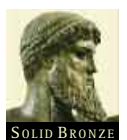
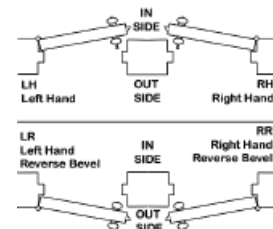

McCall Entrance Handle Sets - Mortise

Applications/Specifications

Applications:

The McCall line of Saint-Gaudens entrance lock has a very simple, elegant design. McCall was designed to emphasize simple understated elegance to highlight the warmth of the bronze finishes. McCall entrance locks are available in tubular or mortise functions. The McCall is available with a square or a curved grip on the outside and either a round or egg knob or a straight lever inside. The rustic finishes, which are Saint-Gaudens trademark, have been softened to enhance the stepped edges of the McCall and are designated Dark Bronze Fine and Satin Bronze Fine.

Advantages:

- ▶ Mortise Lock Body meets ANSI GRADE 1 specifications: ANSI-A15613 and is UL Listed
- ▶ Available 2-3/4" backset standard
- ▶ Solid Bronze Levers/Escutcheons
- ▶ Solid Brass 5-pin 'C' keyway cylinder standard
- ▶ Mortise Lock has emergency egress feature inside lever retracts latch and deadbolt simultaneously, leaving outside locked.

Specifications:

Handing

Mortise locks are handed.

Door Thickness

1-3/4" (44mm) to 2-1/8" (54mm) standard.

Backset

2-3/4" standard, 2-1/2" special order

Front

1-1/4" x 8" with adjustable bevel.

Bolt

Deadbolt constructed of stainless steel.
Deadbolt has 1" throw. Latch throw is 3/4"

Strike

Strike is Straight Lip 4-7/8" ANSI with dust box..

Lock Case

Stamped steel .090 thick, Zinc dichromate finish.

Cylinder

Solid brass, 5-pin, 'C' keyway standard.

Keys/Keying

Two polished brass Saint-Gaudens large bow keys standard. Cylinder easily re-keyed for individual job requirements.

Finishes

Dark Bronze -Fine, Satin Bronze - Fine.

Dimensions

Plate: 3" x 19"

Mortise Locksets install in square mortise door preps. These locks incorporate the latch and deadbolt into one mechanism and by using heavier parts, the longevity and strength of the lock is increased.

Professional Installation Required for Full Warranty.



McCall Entrance Handle Sets - Mortise

Functions

Functions:

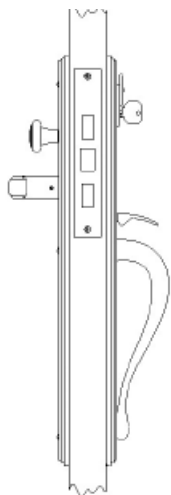

Model

82352-MX*ENT1** (Lever)

*X = L for LH, R for RH **1= 1 for 2-1/2", 2 for 2-3/4" backset

Function

Handle Set with Single
Cylinder Deadbolt

Description

Latch by lever inside or thumbpiece
outside. Deadbolt by turnpiece inside.
Inside lever retracts latch and deadbolt
simultaneously, leaving outside locked.
Deadbolt deadlocks latch.

*Levers are handed –
Please see chart determine the handing of your door.

Professional Installation Required for Full Warranty.

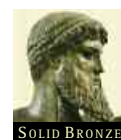
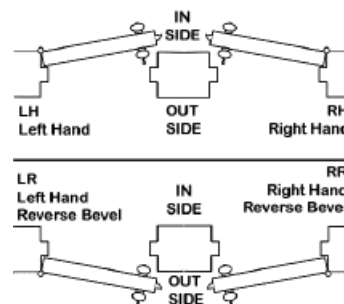

PRODUCT LISTING - MCCALL

Part Number	Product Description
81153-CENTR	Tubular Entry, Round Knob, Curve Grip
81153-CDBL	Tubular Entry, Round Knob, Curve Grip, Double Cylinder
81153-CFD	Entry Set, Round Knob, Curve Grip, Full Dummy
81153-SEINTR	Tubular Entry, Round Knob, Square Grip
81153-SDBL	Tubular Entry, Round Knob, Square Grip, Double Cylinder
81153-SFD	Entry Set, Round Knob, Square Grip, Full Dummy
81053-CENTR	Tubular Entry, Oval Knob, Curve Grip
81053-CDBL	Tubular Entry, Oval Knob, Curve Grip, Double Cylinder
81053-CFD	Entry Set, Oval Knob, Curve Grip, Full Dummy
81053-SEINTR	Tubular Entry, Oval Knob, Square Grip
81053-SDBL	Tubular Entry, Oval Knob, Square Grip, Double Cylinder
81053-SFD	Entry Set, Oval Knob, Square Grip, Full Dummy
81353-CLENT	Tubular Entry, Curved Grip, Left Handed Lever
81353-CLDBL	Tubular Entry, Curved Grip, Left Handed Lever, Double Cylinder
81353-CLFD	Entry Set, Curved Grip, Left Handed Lever, Full Dummy
81353-CRENT	Tubular Entry, Curved Grip, Right Handed Lever
81353-CRDBL	Tubular Entry, Curved Grip, Right Handed Lever, Double Cylinder
81353-CRFD	Entry Set, Curved Grip, Right Handed Lever, Full Dummy
81353-SLENT	Tubular Entry, Square Grip, Left Handed Lever
81353-SLDBL	Tubular Entry, Square Grip, Left Handed Lever, Double Cylinder
81353-SLFD	Entry Set, Square Grip, Left Handed Lever, Full Dummy
81353-SRENT	Tubular Entry, Square Grip, Right Handed Lever
81353-SRDBL	Tubular Entry, Square Grip, Right Handed Lever, Double Cylinder
81353-SRFD	Entry Set, Square Grip, Right Handed, Full Dummy
82353-MCLENT1	Mortise Entry, Curve Grip, Left Handed Lever, 2-1/2" Backset
82353-MCRENT1	Mortise Entry, Curve Grip, Right Handed Lever, 2-1/2" Backset



PRODUCT LISTING – MCCALL *(continued)*

Part Number	Product Description
82353-MCLDBL1	Mortise Entry, Curve Grip, Left Handed Lever, Double Cylinder, 2-1/2" Backset
82353-MCRDBL1	Mortise Entry, Curve Grip, Right Handed Lever, Double Cylinder, 2-1/2" Backset
82353-MCLENT2	Mortise Entry, Curve Grip, Left Handed Lever, 2 3/4" Backset
82353-MCRENT2	Mortise Entry, Curve Grip, Right Handed Lever, 2 3/4" Backset
82353-MCLDBL2	Mortise Entry, Curve Grip, Left Handed Lever, Double Cylinder, 2 3/4" Backset
82353-MCRDBL2	Mortise Entry, Curve Grip, Right Handed Lever, Double Cylinder, 2 3/4" Backset
82353-MSLENT1	Mortise Entry, Square Grip, Left Handed Lever, 2-1/2" Backset
82353-MSRENT1	Mortise Entry, Square Grip, Right Handed Lever, 2-1/2" Backset
82353-MSLDBL1	Mortise Entry, Square Grip, Left Handed Lever, Double Cylinder, 2-1/2" Backset
82353-MSRDBL1	Mortise Entry, Square Grip, Right Handed Lever, Double Cylinder, 2-1/2" Backset
82353-MSLENT2	Mortise Entry, Square Grip, Left Handed Lever, 2 3/4" Backset
82353-MSRENT2	Mortise Entry, Square Grip, Right Handed Lever, 2 3/4" Backset
82353-MSLDBL2	Mortise Entry, Square Grip, Left Handed Lever, Double Cylinder, 2 3/4" Backset
82353-MSRDBL2	Mortise Entry, Square Grip, Right Handed Lever, Double Cylinder, 2 3/4" Backset

